



THE NEW PERODUA
ARUZ
ELEVATE YOUR LIFE



Terms and conditions apply.



ELEVATE YOUR LIFE

From its size, looks, efficiency and safety to space, technology, convenience and comfort, Perodua's 7-seater sport utility vehicle (SUV) is the perfect upgrade to your life. With a better driving experience, raised safety standards and aspirational features, the Perodua Aruz will elevate your life to a whole new level of style and sophistication.



EFFICIENCY. ELEVATED.

It's a big world. See it all. An EEV engine with best-in-class fuel efficiency makes Aruz the perfect car for hitting the open road.





EEV Engine

Smooth & quiet drive.



Best-in-class

15.6 km/l*



'Eco Idle' System

The system reduces fuel consumption and emissions.

CONVENIENCE. ELEVATED.

From A to B and anywhere in between, there is plenty of thoughtful technology in the Aruz that makes driving fun and comfortable.





Auto Light Control*



Reverse Camera

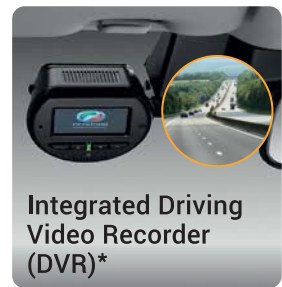

Integrated Driving Video Recorder (DVR)*



Built-in Toll Reader

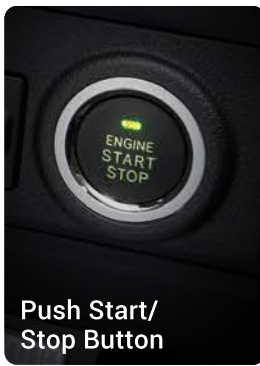

Push Start/ Stop Button



Digital Aircond Controller

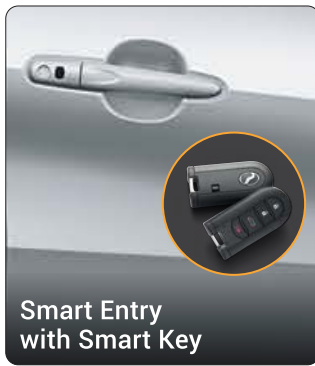

Smart Entry with Smart Key



Multimedia System with Navigation and 'Smart Link' for Android*

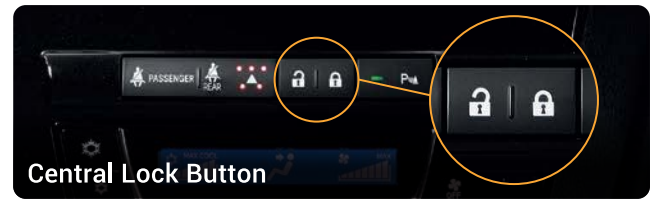

Central Lock Button

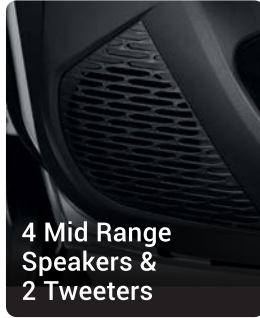

4 Mid Range Speakers & 2 Tweeters



Front Row - USB & HDMI* Ports



Middle Row - USB Port



Third Row - 12V/60W Port

Charging Port In All Rows

*AV variant only.

STYLE. ELEVATED.

All eyes on you and your ride. The Aruz features an aerodynamic body with distinctive accents that attract all the right attention.



SPORTY & DYNAMIC DESIGN

**LED Headlamps with
Follow-me-home Function & Light Guides**

**Fog Lamps with
Stylish Bezel***

**17-inch
Alloy Rims**

**Sporty
Roof Rail***

**Window with
Chrome Finish**

*AV variant only.

STYLE. ELEVATED.

All eyes on you and your ride. The Aruz features an aerodynamic body with distinctive accents that attract all the right attention.



SPORTY & DYNAMIC DESIGN

*Shark Fin
Antenna*

*Rear
Spoiler*

*LED Rear
Combination Lamps*

*Backdoor Garnish with
Chrome and Glossy Black Finish**

*Two-tone Bumper with Silver
Painted Diffuser**

*AV variant only.

SPACE. ELEVATED.

Aruz has space for all the things you're into. It offers flexible seating arrangements and generous luggage space on days when travelling light just isn't an option.



FLEXIBLE
Seating Arrangements



5-SEATER MODE

Road trips are always better with your loved ones.



SPORTS MODE

Pack it all in for weekend adventures.



LONG ITEM MODE

Ready for just about everything.



LEISURE MODE

Load it up and pack it in.



NORMAL MODE

More room for more stuff.



COMFORT. ELEVATED.

Soak in the comforts of a striking interior packed with purposeful features that make every trip an opportunity to treat yourself.





Adjustable Leather-wrapped Steering Wheel with Audio & 'Receive Call' Control*



Side Mirror Control



Rear Aircond Vents



Driver Seat Height Adjuster

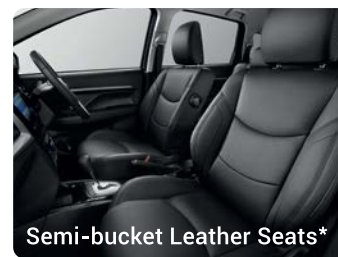

Semi-bucket Leather Seats*



Sporty White-illuminated Meter Panel with LCD Multi-info Display



Gated Gear Shift



2nd Row Sliding Seats

*AV variant only.

SAFETY. ELEVATED.

Advanced safety technologies help you detect and prevent potential hazards on the road, so you can feel confident every time you get behind the wheel.

ADVANCED SAFETY ASSIST (A.S.A.) 2.0 WITH PEDESTRIAN DETECTION*

Our safety technology has been upgraded to detect both vehicles and pedestrians. It now helps to reduce low- to medium-speed accidents due to inattentive driving.

Please refer to owner's manual for more details.



**SAFETY.
ELEVATED.**





5-star ASEAN NCAP Safety Rating

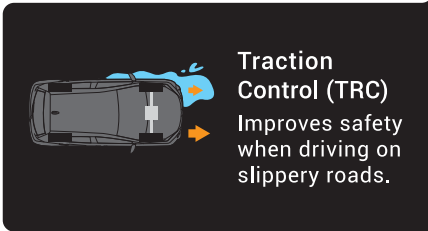

Anti-lock Braking System (ABS) with Electronic Brake Distribution (EBD) and Brake Assist (BA)

The ABS function prevents the tyres from locking when braking, avoiding uncontrollable skids and maintaining steering control.

ABS WITH ABS
 Braking point: [Diagram showing stable braking with ABS]

WITHOUT ABS
 Braking point: [Diagram showing wheel lock and skidding without ABS]

EBD WITH EBD
 [Diagram showing balanced braking force distribution]

WITHOUT EBD
 [Diagram showing uneven braking force distribution]



Emergency Stop Signal (ESS)
 ESS automatically activates Hazard Warning Lights during hard braking to alert the drivers of trailing vehicles.

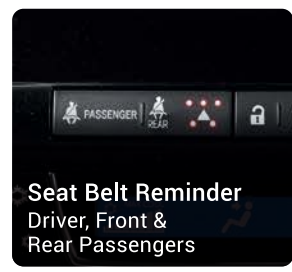
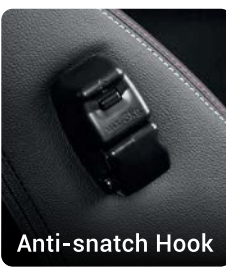

VARIANT COMPARISON



1.5 AV DIFFERENCES FROM 1.5X



Multimedia System with Navigation

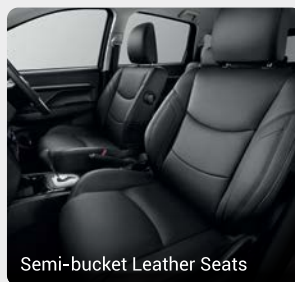

Semi-bucket Leather Seats

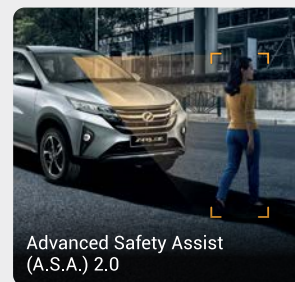

Advanced Safety Assist
(A.S.A.) 2.0

- Sporty Roof Rail
- Front Grille with Chrome & Glossy Black Finish
- Backdoor Garnish with Chrome & Glossy Black Finish
- Auto Light Control
- HDMI Port



Integrated Driving
Video Recorder
(DVR)



'Smart Link' for Android



Fog Lamps with
Stylish Bezel



Front Bumper with
Silver Painted Diffuser

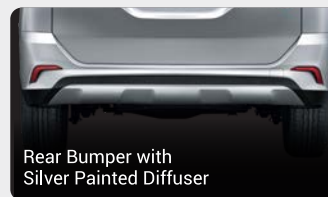

Rear Bumper with
Silver Painted Diffuser

VARIANT COMPARISON



1.5X



Digital Audio System with Bluetooth, USB & MP3

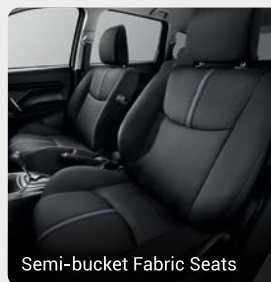

Semi-bucket Fabric Seats

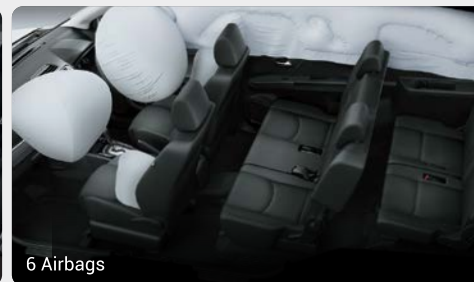

6 Airbags

- 5-star ASEAN NCAP Safety Rating
- Vehicle Stability Control (VSC) and Traction Control (TRC)
- Anti-lock Braking System (ABS) with Electronic Brake Distribution (EBD) & Brake Assist (BA)
- Hill-start Assist (HSA)
- Emergency Stop Signal (ESS)
- 17-inch Alloy Rims
- ISOFIX System
- Seat Belt Reminder (Driver, Front & Rear Passengers)
- One-touch Power Window with Jam Protection (Driver Side)
- Headlamp Levelling Adjuster
- Chrome Inner Door Handles
- Air Conditioner (With Rear Vents)
- Anti-snatch Hook
- Speed-linked Intermittent Front Wiper

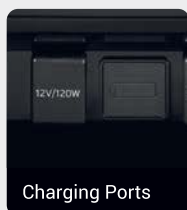

Charging Ports



Reverse Camera

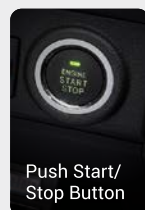

Push Start/Stop Button

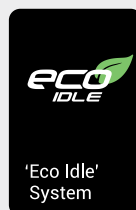

'Eco Idle' System



Solar & Security Window Film



Smart Entry with Smart Key



Built-in Toll Reader

GearUp® PERODUA ORIGINALS

Personalise the aesthetics of your Aruz with GearUp® accessories. It's a dash of smart design that elevates the Aruz's sporty style.



GearUp[®]

Perodua Originals

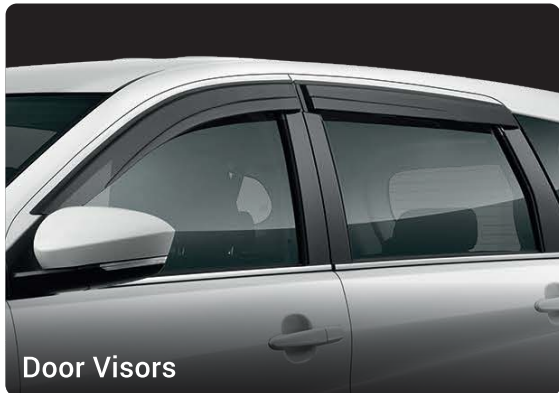

Door Visors

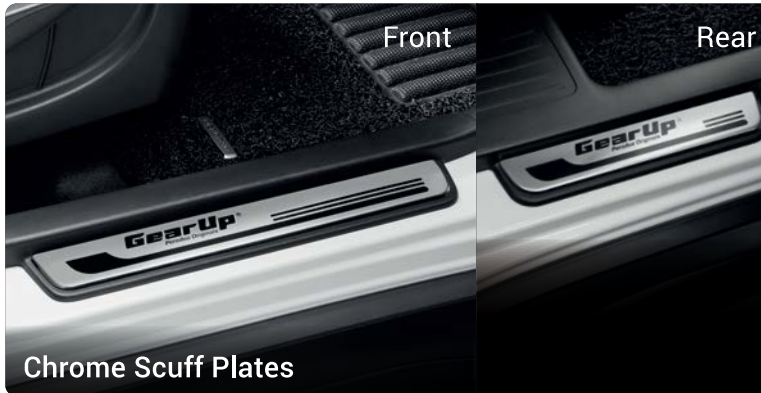

Chrome Scuff Plates



Hood Insulator

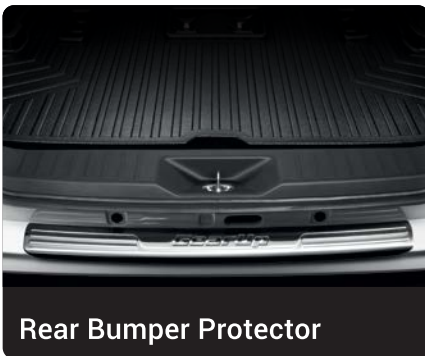

Rear Bumper Protector



Luggage Tray



Coil Mats



Door Comfort

6 - MONTH WARRANTY
Terms and conditions apply.

INSTALMENT PLAN AVAILABLE*
*For new car purchases only.

TECHNICAL SPECIFICATIONS

MODEL		ARUZ 1.5ℓ	
TRANSMISSION		X	AV
TRANSMISSION		4 E-AT	
DIMENSIONS & WEIGHT			
Overall length/width/height	mm	4,435/1,695/1,740	
Wheelbase	mm	2,685	
Track	Front	1,445	
	Rear	1,460	
Ground clearance	mm	220	
Minimum turning radius	m	5.2	
Kerb weight	kg	1,300	1,310
Luggage capacity	ℓ	213/514 (with 3 rd row seat down)	
Fuel tank capacity	ℓ	45	

ENGINE			
Engine type	2NR-VE, 4 cylinders, DOHC with DUAL VVT-i		
Total displacement	cc	1,496	
Maximum output	kW/rpm	75/6,000	
Maximum torque	Nm/rpm	133/4,200	
Fuel consumption (with Eco-driving)	km/ℓ	15.6 (with 'Eco Idle' system)	
'Eco Idle' system (Idling stop system)		•	•

CHASSIS			
Electric power steering (EPS)		•	•
Tyres, disc wheels & spare tyre		215/60 R17 (17-inch alloy rims)	

SAFETY & SECURITY			
Airbags		6 (front, side & curtain)	
ABS with EBD & BA		•	•
Vehicle stability control (VSC)		•	•
Traction control (TRC)		•	•
Emergency stop signal (ESS)		•	•
Hill-start assist (HSA)		•	•
Advanced safety assist (A.S.A.) 2.0		-	•
Reverse camera		•	•
Integrated driving video recorder (DVR)		-	•
ISOFIX system with top tether		•	•
Solar and security window film		•	•

DIMENSIONS

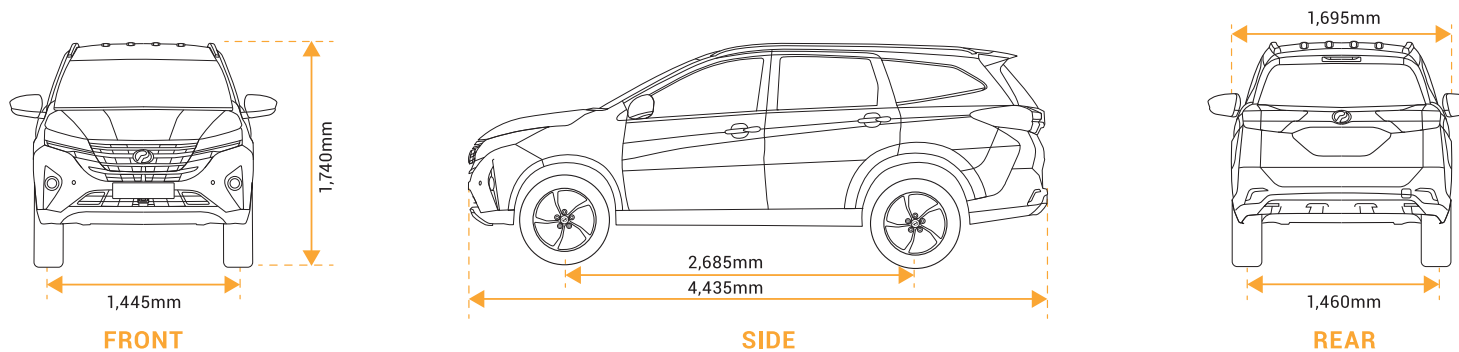

MODEL		ARUZ 1.5ℓ	
		X	AV
TRANSMISSION		4 E-AT	
EXTERIOR			
Front grille		Chrome & glossy black finish	
Two-tone front & rear bumpers		Material color diffuser	Silver painted diffuser
Side mirrors with turn signals		Electric & retractable	
Front fog lamps		-	•
Headlamps	Type	LED with follow-me-home function & light guides	
	Auto-on	-	•
	Levelling	Manual	
Rear combination lamps		LED type (tail & brake)	
Spoiler		•	•
Roof rail		-	•
INTERIOR			
Meter combination		White illumination with painted ring	White illumination with chrome ring
Shift bezel (gate type)		Urethane	Leather
Seats	Material	Fabric	Leather
	Front seats	Separated type	
	Second row seats	Foldable with one touch & slidable	
	Third row seats	Separated & foldable	
COMFORT			
Smart entry & push start/stop button		•	•
Built-in toll reader		•	•
Audio		Digital audio system with bluetooth, USB, MP3 & resistive touch panel	Multimedia system with navigation, 'Smart Link' (for Android) & HDMI
Speakers		6 speakers (tweeter, front & rear)	
USB port		2 (front & driver seat)	
12V power socket		2 (front & 3 rd row)	
Air conditioner	Digital	Front	
	Manual	Rear vents	
ACCESSORIES			
Carpet mat		•	•
Safety triangle		•	•
Registration plate holder		•	•

Only the main differences between variants are listed here. For a list of features common to all variants, please consult a Perodua sales advisor.

COLOURS

NEW COLOUR



Amazon Green (Metallic)



Granite Grey (Metallic)



Electric Blue (Metallic)



Glittering Silver (Metallic)



Ivory White (Solid)

Colours shown here may differ from the colours of the actual vehicles.

THE NEW PERODUA

ARUZ

ELEVATE YOUR LIFE

PERODUA SALES SDN BHD (066332U)
Sungai Choh, Locked Bag 226, 48009 Rawang,
Selangor Darul Ehsan, Malaysia.
www.perodua.com.my



UFirst*
Perodua Passport for brighter and better days. Sign up now at www.ufirst.com.my and download the mobile app to enjoy more benefits.



Perodua Total Protect with 24-hour Auto Assist*
Enjoy peace of mind. Every new Perodua comes insured with Total Protect, which includes a free towing service and emergency assistance on-call 24/7 (1800-88-5555). Plus, you can renew your car insurance at any authorised Perodua outlet.

**Terms and conditions apply.*